

# **LDC031 Series**

## **Hidden Installation**

### **All-in-One Direct View LED Display**

**Installation Guide**

**快速入門指南**

**Guide de démarrage rapide**

**Schnellstartanleitung**

**Guía rápida de inicio**

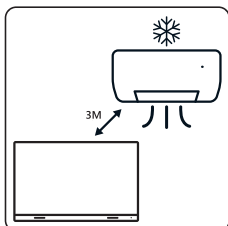
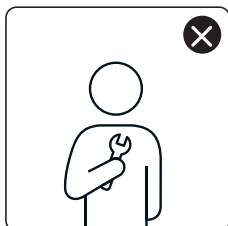
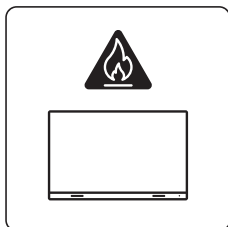
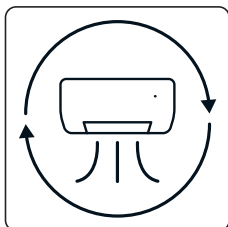
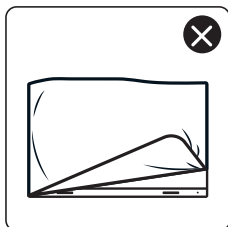
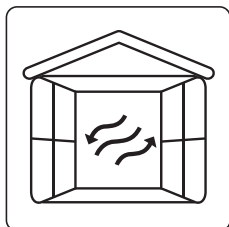
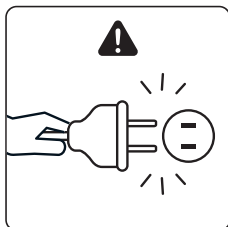
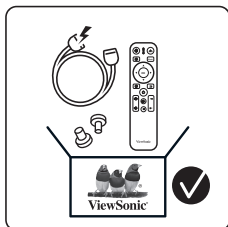
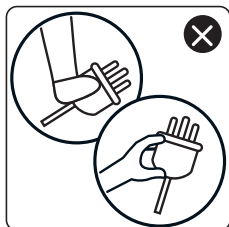
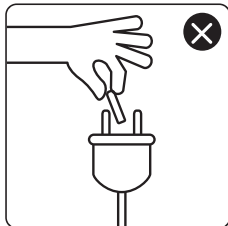
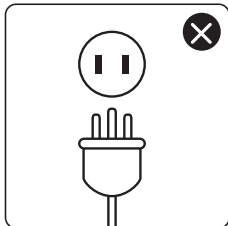
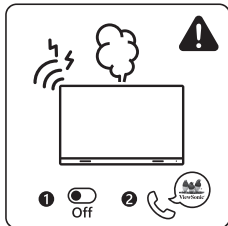
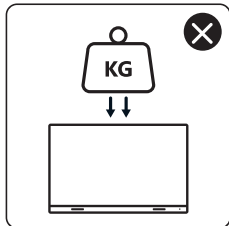
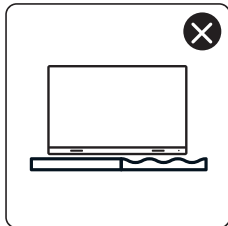
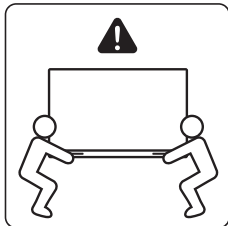
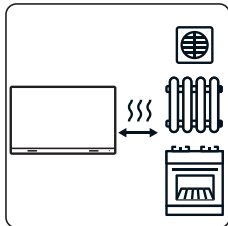
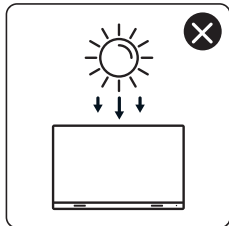
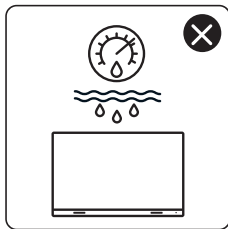
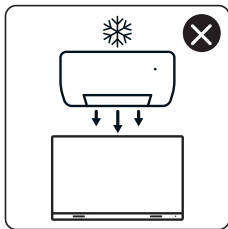
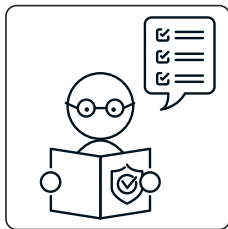
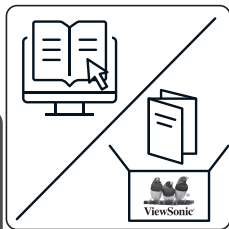

## FCC Compliance Statement

This device complies with part 15 of FCC Rules. Operation is subject to the following two conditions: (1) this device may not cause harmful interference, and (2) this device must accept any interference received, including interference that may cause undesired operation.

**Industry Canada ICES-003 Statement:** CAN ICES-003(B) / NMB-003(B)

## CE Conformity for European Countries

The device complies with the EMC Directive 2014/30/EU, Low Voltage Directive 2014/35/EU and Radio Equipment Directive 2014/53/EU.

## Declaration of RoHS2 Compliance

This product has been designed and manufactured in compliance with Directive 2011/65/EU of the European Parliament and the Council on restriction of the use of certain hazardous substances in electrical and electronic equipment (RoHS2 Directive) and is deemed to comply with the maximum concentration values issued by the European Technical Adaptation Committee (TAC).

**For EU users, please contact us for any safety/accident issue experienced with this product:**

ViewSonic Europe Limited



Haaksbergweg 75  
1101 BR Amsterdam  
Netherlands



+31 (0) 650608655



EPREL@viewsoniceurope.com



<https://www.viewsonic.com/eu/>

# Introduction

The step-by-step instructions in this guide are a general reference for installing the LED Display. If any details in this document are unclear, please contact your reseller for more information.

## Before Installing

- ❗ Ensure there is no direct airflow from air conditioning or heating vents blowing on the LED Display.
- ❗ Avoid installing the LED Display in places with high humidity.
- ❗ Due to high power usage, always use power cords specifically designed for this product.
- ❗ Wood may split if holes are not pre-drilled before installing the Wall Mount Brackets.
- ❗ Ensure the deviation of the wall surface is  $< 5$  mm.
- ❗ Wear protective gear, such as gloves and protective shoes, when handling the LED Display.
- ❗ Due to the size and weight, it is recommended that two or more people handle it.

## Wall Mounting

There are two types of the Wall Mount Brackets for installing our LED Display: the Wall Mount Brackets with the Wall Mount Connector Plate and those without the Wall Mount Connector Plate. Before the installation, please ensure the Wall Mount Brackets supplied in the case match the ones illustrated in Appendix A.

1. Please take a moment to check the following when deciding the installation location. However, for the best results, it is recommended to ask your reseller or licensed professional to install the LED Display.
  - The wall space.
  - The wall type.
  - The power consumption.
  - The installation type.
  - Cable pathways between the Cabinets, and between the Cabinets and System Control Box.

**NOTE:** Refer to Appendix A for the detailed instructions on mounting the Wall Mount Brackets, including minimum space requirements.

2. Install the first Upper Wall Mount Bracket with the provided screws (M8 x 80 mm Expansion).
3. Repeat **Step 2**, ensuring the second Upper Wall Mount Bracket is level with the first Upper Bracket.

**NOTE:** It is recommended to use a laser or torpedo level.



4. Repeat **Step 2~3** for the remaining Upper Wall Mount Bracket(s).
5. Install the Lower Wall Mount Brackets in the same manner as the Upper Wall Mount Brackets.

**NOTE:** You can also install the Upper Wall Mount Brackets, hang the screen, and then install the Lower Wall Mount Brackets for a more precise fit.

## Installing the Cabinets

Before installing the Cabinets on the Wall Mount Brackets, it is recommended to refer to the wiring diagram provided in Appendix B first to decide how you want to route the Cables for the power and network connections to the Cabinets.

Additionally, the rubber hole plugs installed on the Cabinets are used to protect the Power and Network Cables from rubbing against any pointed edges. After installing all Cabinets, use a knife to cut the rubber hole plugs to size along the cross according to the thickness of the Cables.

1. Locate the Cabinet to install the left Upper System Control Box Mount Bracket (see Appendix B to identify the Cabinet).

**NOTE:**

- One Cabinet is divided into separate sections. You can identify these Cabinet sections by the labels on each section or the package.
  - The arrow marks on each Cabinet section should be pointing up.
2. Place each section of the Cabinet on stable furniture that can safely support them.
  3. Attach the Cabinet sections together with the provided screws (M8 x 20 mm).
  4. Install the left Upper System Control Box Mount Bracket to the side of the assembled Cabinet with the provided screws (M8 x 20 mm).
  5. Repeat **Step 1~4** for the right Upper System Control Mount Bracket.
  6. Repeat **Step 2~3** for the first Cabinet. Start from the center, and move to the right and left sides of the Wall Mount Brackets (see Appendix B to identify Cabinet sections and installation sequence)
  7. Carefully lift the assembled Cabinet onto the center of the Upper Wall Mount Brackets.

8. Ensure the Mounting Brackets sit securely on the Wall Mount Brackets as shown below.

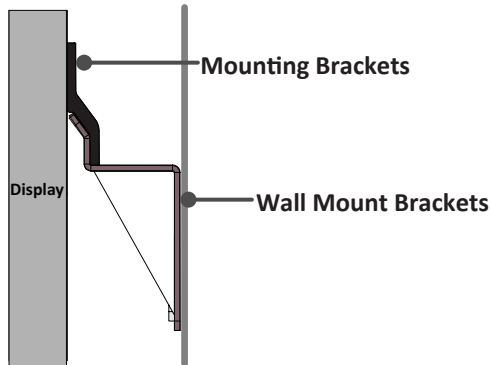

9. Repeat **Step 2~3** for the second Cabinet, ensuring it sit securely on the Wall Mount Brackets.
10. Install the first and second Cabinets together with the provided screws (M8 x 20 mm).
11. Check for unevenness of the Cabinets by rubbing the cross section between each Cabinet. If the cross section is not aligned, loosen the M8 screws slightly and tap the Cabinets until the cross section is flat.

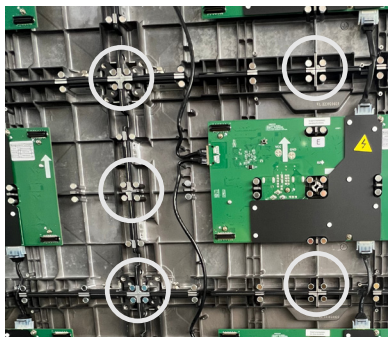

12. Assemble and install the remaining Cabinets in the same manner as the first two Cabinets. Ensure the Mounting Brackets sit securely on the Wall Mount Brackets, and that the Cabinets are properly secured together.

**NOTE:** Refer to Appendix B to identify the Cabinets and installation sequence.

13. After installing all Cabinets, cut the rubber hole plugs to size along the cross with a knife (see Appendix B for the position of the hole plugs).

## Connecting and Installing the System Control Box

The left and right sides of the System Control Box are pre-installed with its Covers in the factory. The main system control board is on the right.

- ❗ The safety wires are used to prevent the Right Cover from falling when accessing the System Control Box. Please ensure that the safety wires are never removed.
- ❗ Use caution as the System Control Box panel is separated into two pieces with wires attached.
- ❗ Before installing the System Control Box, the Power and Network Cables of the Cabinets at the lowest row must be routed through the holes provided in the System Control Box from behind (see Appendix B for example system wiring diagram).

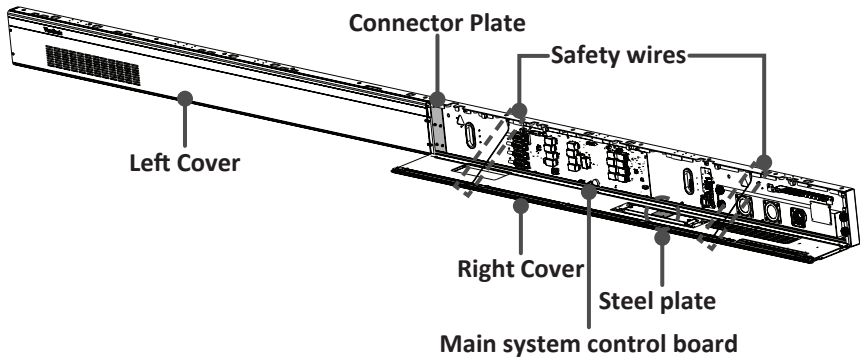

1. Carefully place the System Control Box on stable furniture that can safely support the System Control Box.
2. The rubber hole plugs installed on the rear of the System Control Box are used to protect the Cables from rubbing against any pointed edges. Use a knife to cut the hole to size along the cross.

3. To open the Right Cover, slowly bring the supplied Maintenance Tool near the surface of the Right Cover where the steel plate is located. Then, the Right Cover should detach from the System Control Box magnetically.

**!** DO NOT try to remove or disconnect the safety wires. Please ensure that the safety wires are never removed.

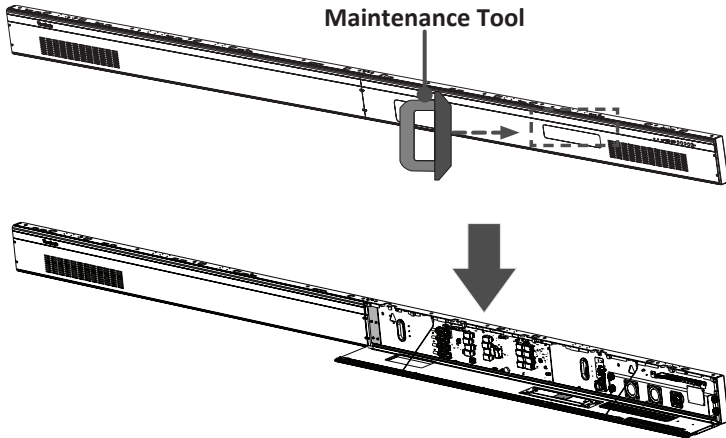

4. Remove the Left Cover by gripping the top edge of the Cover and pulling it toward you. The Left Cover should simply lift away.

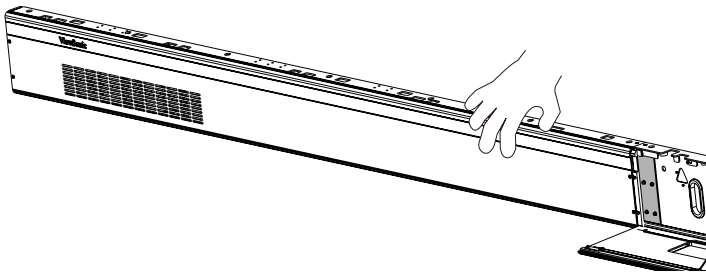

5. Secure the System Control Box panel with the Connector Plate using the provided screws (M3 x 6 mm).

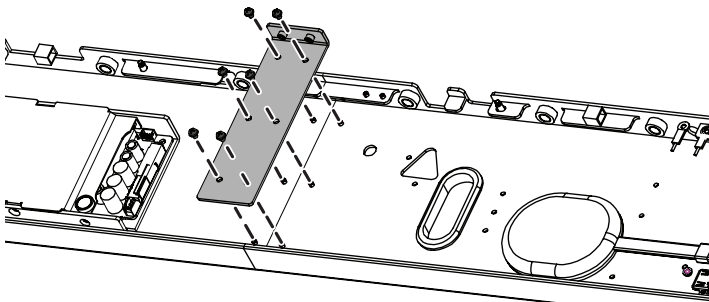

- Further secure the Connector Plate with the two provided screws (M3 x 5 mm).

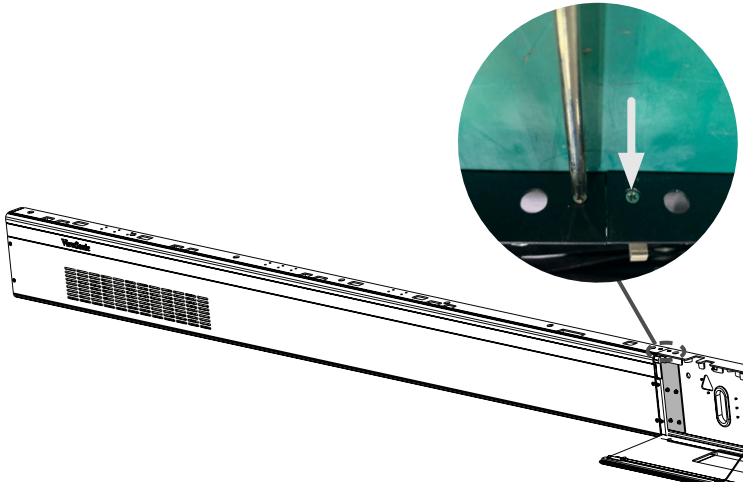

- Install the short side of the Lower System Control Box Mount Bracket onto the top of the System Control Box with the provided screws (M3 x 6 mm).

**NOTE:** There are two Lower System Control Box Mount Brackets to install.

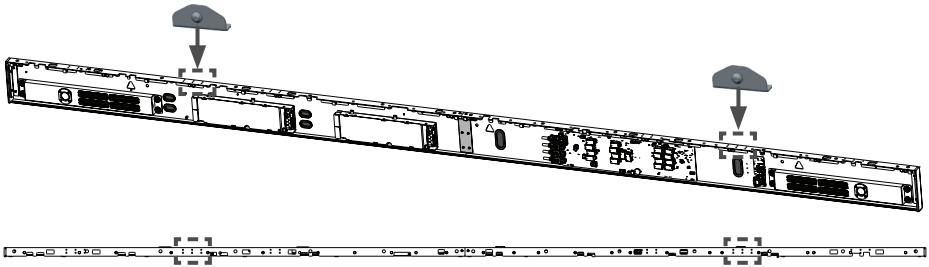

*Installing the Lower System Control Box Mount Brackets onto the System Control Box (Front and Top Views)*

8. Install the provided screw (M8 x 16 mm) on the Lower System Control Box Mount Bracket. Thread the provided M8 nut onto the screw and fully tighten the nut.

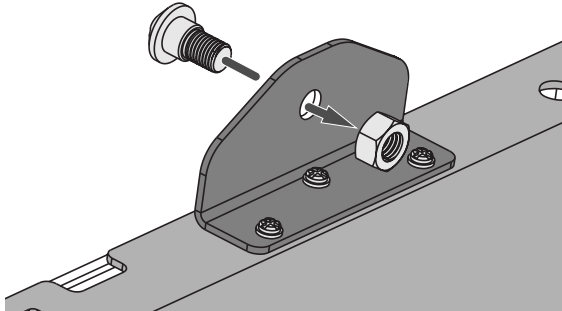

9. Repeat **Step 7** for the other Lower System Control Box Mount Bracket.
10. Remove the pre-installed Power and Network Cables of the Cabinets from the System Control Box.

**NOTE:** It is recommended to take photos of the completed wiring in the left and main system control boards before removing the Cables.

11. After removing the pre-installed Power and Network Cables of the Cabinets, connect one end of the longer Network Cable to the network port that was disconnected from the System Control Box in **Step 10**.

**NOTE:**

- Refer to Appendix B for example system wiring diagrams, including wire colors and connection points.
  - Ensure to match the corresponding letters on the Cables to the network ports of the System Control Box (A to A, B to B, C to C, and so on).
12. Carefully thread the Network Cables through the hole provided in the System Control Box to the rear (see Appendix C for the position of the cable holes). Avoid sharp bends in the Cables.

**NOTE:** The rubber hole plugs must always be placed in the holes.

13. After threading all Network Cables of the Cabinets, connect the longer Power Cables to the AC unit(s) of the System Control Box.

- ❗ DO NOT connect the System Control Box Power Cable(s) at this time.
  - Connect the neutral wires (usually white/blue) to the "N1" and "N2" terminals.
  - Connect the hot wires (usually black/brown) to the "L1" and "L2" terminals.
  - Connect the ground wires (usually in green) to the ground terminals.
- ❗ The meaning of wiring color may vary by country.
- ❗ Use the provided wrench to tighten the neutral, hot, and ground conductors in the terminals properly.

14. Thread the Power Cables of the Cabinets through the hole provided in the System Control Box to the rear (see Appendix C for the position of the cable holes). Avoid sharp bends in the Cables.

**NOTE:**

- The rubber hole plugs must always be placed in the holes.
- Before threading the Cables through, ensure that the output and input terminals are properly grounded, and that the wire colors/labels are matched with the marked terminals and each wire is screwed firmly to its corresponding terminal.

15. Connect the AC unit(s) of the System Control Box to the main system control board.
16. Connect the LED Display's left speaker to the Audio Out port.

**NOTE:** Ensure that the right speaker is properly connected to the other Audio Out port.

17. Connect the IR Extension Cable to the main system control board. Then, route it through the hole of the System Control Box to the rear.

**NOTE:** Refer to Appendix C for the position of the cable holes.

18. After connecting all Cables and wires, hold the top edge of the Right Cover toward the System Control Box to replace it. Once the Right Cover is replaced, it will be held in place magnetically.

**NOTE:** Ensure the Power Button cable is connected before securing the Right Cover.

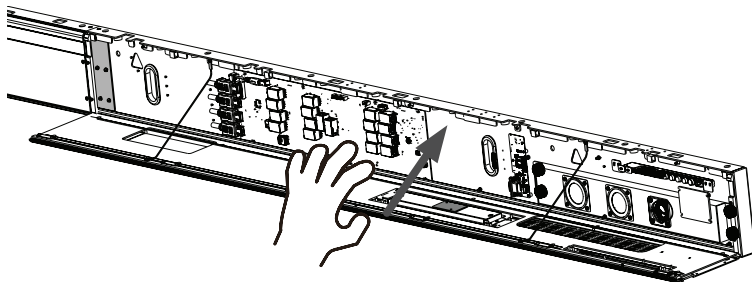

19. Replace the Left Cover by aligning it properly with the System Control Box; then the Left Cover should attach magnetically.
20. Align the Lower System Control Box Mount Brackets with the Upper Mount Brackets to attach.
21. Thread the Power and Network Cables through the holes at the lowest row of the Cabinets to the front.

**NOTE:** Ensure to match the corresponding letters on the Cables to the Cabinets (A to A, B to B, C to C, and so on).

22. Carefully place the Lower System Control Box Mount Brackets onto the Upper System Control Box Mount Brackets.
23. Ensure the Lower System Control Box Mount Brackets sit securely on the Upper.

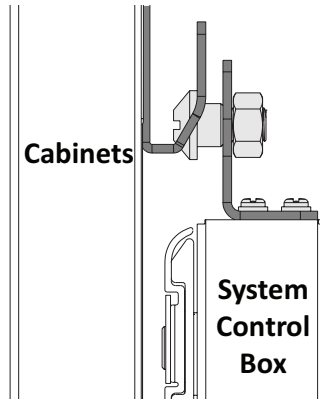

24. After installing the System Control Box, connect the Power and Network Cables from the System Control Box to each Cabinet. Start from the bottom and move to the top (see Appendix B for example system wiring diagrams, including wire colors and connection points).
25. Route the Power and Network Cables around the rods provided in the Cabinets and secure the Cables to the rods with the Cable Zip Tie and screw (PM3 x 10 mm). Leave a little slack for later adjustments if needed.

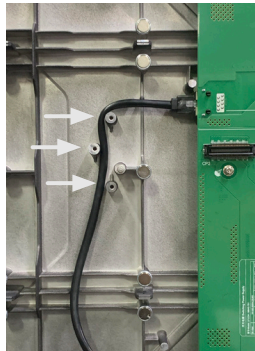



## Installing the LED Modules

- ❗ Please wear Anti-Static Gloves before handling the LED Modules.
- ❗ To avoid direct contact with the LED Modules, please remove watches, rings, bracelets, or other metal objects.
- ❗ Use caution when installing the LED Modules.

1. Starting from the LED Module labeled "1", align each LED Module with the Cabinet, then carefully press the Module into place.

**NOTE:** The arrow marks on the back of the LED Modules should be pointing up.

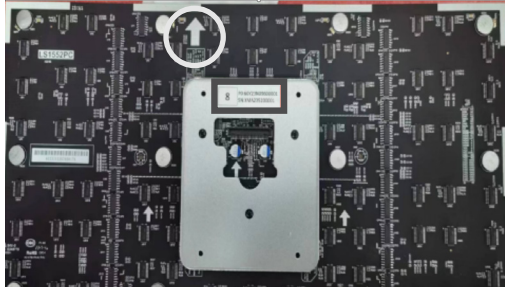

2. Attach the remaining LED Modules onto the Cabinets. Install from top left and move to bottom right, ensuring to match the corresponding numbers on the Module to the Cabinet. See Appendix C for further guidance on the LED Modules.

**NOTE:** Before installing the LED Module, ensure that each Module is flush and that there is little to no gap between each. It may be necessary to gently tap the module to make it flush.

## Installing the Screen Bezels

- ❗ The Screen Bezels' plastic tabs are pre-installed onto the Bezels. Ensure all plastic tabs are properly mounted before installing the Screen Bezels onto the screen.
- ❗ The label indicates the top of each Screen Bezel. To ensure the Bezels are installed in the correct position, please use the labels on the inside of the Bezels as a guide.

Plastic tabs

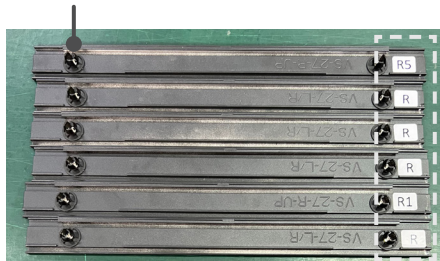

1. Place the Screen Bezel to the correct side of the screen to attach. Start from the left and move to the right.

**NOTE:**

- Ensure the label side of the Screen Bezel is facing the screen.
  - Before installing the Screen Bezels, check the label of each Bezel as the label helps you know which side ("L" = left side & "R" = right side) to attach.
  - The Screen Bezels without the labels on are for the bottom of the screen. For the bottom Screen Bezels, orientation or position does not matter.
  - If a Screen Bezel does not seem to fit, lift it up with caution and check if it is on the correct side to install. If the Bezel does not seem to fit at all, please contact your reseller. DO NOT force it into place.
2. Align the plastic tabs of the Screen Bezel with the holes provided in the screen.



3. Press down on the Screen Bezel until you hear it click into place.
4. Place the remaining Screen Bezels onto the left and right sides of the screen.

## Turning On the LED Display

1. Make sure the System Control Box Power Cable(s) is connected and plugged into power outlet(s).

**NOTE:** When the System Control Box Power Cable(s) is connected to power outlet(s), the Power Indicator Light will be a steady red. This means the LED Display is in standby mode. Please refer to the User Guide for more details.

2. Your LED Display is now ready to power on.

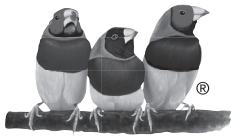

**ViewSonic®**